

Shelving, Hardware & Pegboard Accessories



Wall Standards & Brackets

Hangrail Systems

Pegboard Accessories

Channel & Data Tracs

Terms & Conditions

- Applicable taxes are extra on all prices
- Prices are subject to change without notice and will be invoiced at the price in effect at the time of order
- Volume discounts are available on most items
- Faxed or emailed order confirmations are encouraged
- Payment is required on all first-time orders before shipment
- We accept Visa, MasterCard, Debit, Cheque, or Cash
- Accounts are strictly Net 30 Days upon approved credit
- To establish an account, please ask for our credit application form and fill it out and return it
- We reserve the right to request a deposit on all larger and/or custom orders
- A 15% re-stocking charge applies to all returns
- All acrylics, custom orders, and "Clearance" items are non-returnable

Shipping

- All orders are shipped F.O.B. St. Jacobs, Ontario
- Most small shipments will be sent via Canpar and large shipments will be sent via common carrier unless otherwise specified
- Shipping charges will be added to the invoice amount unless order is shipped collect
- Shipping dates are based on prompt receipt of necessary information

Kraemer Woodcraft Ltd.
11 Henry Street West, Box 510
St. Jacobs, ON N0B 2N0
Tel 519-664-2221 Fax 519-664-2105

info@kraemerwoodcraft.com
www.kraemerwoodcraft.com



Table of Contents

Product Description	Page
Terms & Conditions	2
Table of Contents	3
Melamine Shelves & Brackets	4
Wall Standards & Crossbars.....	5
Rectangular Crossbar Accessories	6
Round Hangrail System	7

Melamine Shelves & Brackets

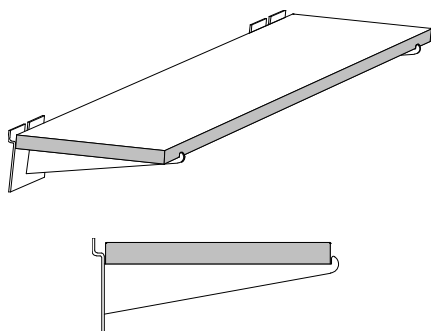

End View

Melamine Shelves

- 3/4" Thick
- Available in Almond, Black, White, Light Grey, Dark Grey & Hardrock Maple
- Non-Stock Item
- Custom Sizes Available
- Price on Request

Order #	Price	Size
3-MS-0824	POR	8" x 24"
3-MS-1024	POR	10" x 24"
3-MS-1224	POR	12" x 24"
3-MS-0848	POR	8" x 48"
3-MS-1048	POR	10" x 48"
3-MS-1248	POR	12" x 48"
3-MS-1448	POR	14" x 48"

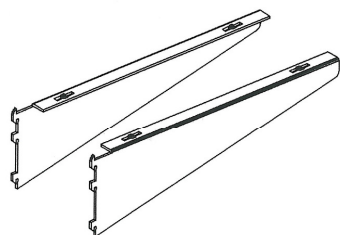

Wood Shelf Bracket

- Bright Zinc
- Sold in Pairs
- For 1/2" Slot, 1" O.C.
- 8", 18" & 20" are Non-Stock

Order #	Price	Size
3-1513-08	\$7.45/Pair	8"L
3-1513-10	\$8.35/Pair	10"L
3-1513-12	\$10.70/Pair	12"L
3-1513-14	\$11.85/Pair	14"L
3-1513-16	\$14.30/Pair	16"L
3-1513-18	\$14.55/Pair	18"L
3-1513-20	\$16.45/Pair	20"L

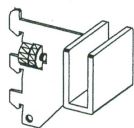

Hangrail Centre Bracket

- For Rectangular Hangrail
- 1/2" Slot
- 2-1/2" & 12"L

Order #	Price	Size
3-1910	\$5.90	2-1/2"L
3-1915	\$10.55	12"L

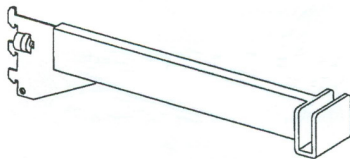

Hangrail End Bracket

- Chrome
- Sold in Pairs

Order #	Price	Size
3-1905	\$10.75/Pair	2-1/2"L

Kraemer Woodcraft Ltd.

11 Henry Street West, Box 510
St. Jacobs, ON N0B 2N0
Tel 519-664-2221 Fax 519-664-2105

info@kraemerwoodcraft.com
www.kraemerwoodcraft.com



Wall Standards & Crossbars

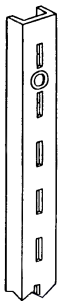

Single Slot Heavy Duty Wall Standard

- 1/2" Slot, 1" on Centre
- Chrome
- Stock 48" Only

Order #	Price	Size
3-1403-48-C	\$10.20	48"L
3-1403-60-C	\$11.40	60"L
3-1403-72-C	\$14.90	72"L
3-1403-84-C	\$18.00	84"L
3-1403-96-C	\$19.90	96"L



Double Slot Heavy Duty Wall Standard

- 1/2" Slot, 1" on Centre
- Chrome
- Special Order Item

Order #	Price	Size
3-1404-48-C	\$13.35	48"L
3-1404-60-C	\$18.25	60"L
3-1404-72-C	\$22.35	72"L
3-1404-84-C	\$26.30	84"L
3-1404-96-C	\$30.75	96"L

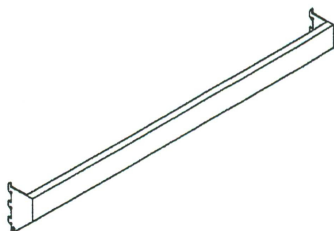

Straight Hangrail

- 1/2" x 1-1/2" Rectangular Hangrail
- Chrome
- Special Order Item

Order #	Price	Size
3-1708-24	\$13.65	24"L
3-1708-36	\$17.40	36"L
3-1708-48	\$22.35	48"L

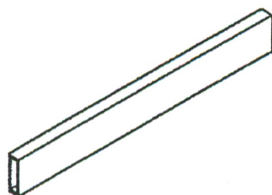

Rectangular Hangrail

- 1/2" x 1-1/2" Tubing
- Chrome
- Stock 48" Only
- Other Sizes are Special Order

Order #	Price	Size
3-1900-24	\$6.60	24"L
3-1900-36	\$10.00	36"L
3-1900-48	\$13.90	48"L
3-1900-60	\$16.50	60"L
3-1900-72	\$18.65	72"L
3-1900-96	\$26.65	96"L

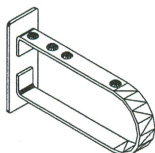

Hangrail End Cap

- Chrome

Order #	Price	Size
3-1903	\$1.35	N/A

Kraemer Woodcraft Ltd.

11 Henry Street West, Box 510
St. Jacobs, ON N0B 2N0
Tel 519-664-2221 Fax 519-664-2105

info@kraemerwoodcraft.com
www.kraemerwoodcraft.com



Rectangular Crossbar Accessories

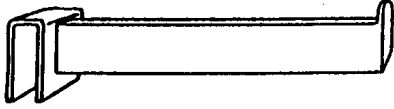

Straight Faceout Bracket

- Chrome
- Special Order Item

Order #	Price	Size
3-1800-12	\$6.60	12"L

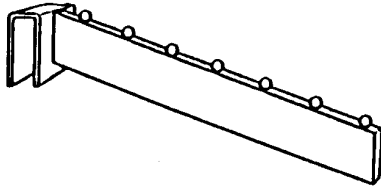

7-Ball Waterfall Bracket

- Chrome
- Special Order Item

Order #	Price	Size
3-1802	\$9.45	16"L

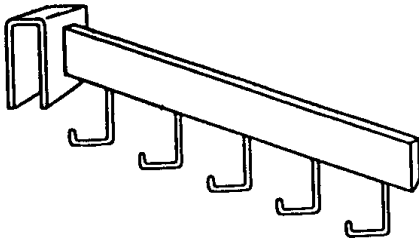

5-Hook Waterfall Bracket

- Chrome
- Special Order Item

Order #	Price	Size
3-1803	\$10.70	16"L



Single Metal Hook

- 1/4" Wire
- Chrome

Order #	Price	Size
3-1804-04	\$0.95	4"L
3-1804-06	\$1.30	6"L
3-1804-08	\$1.35	8"L
3-1804-10	\$1.45	10"L
3-1804-12	\$1.65	12"L

Kraemer Woodcraft Ltd.

11 Henry Street West, Box 510
St. Jacobs, ON N0B 2N0
Tel 519-664-2221 Fax 519-664-2105

info@kraemerwoodcraft.com
www.kraemerwoodcraft.com



Round Hangrail System

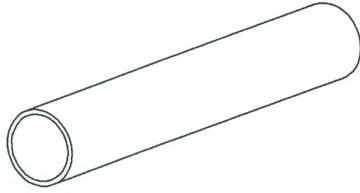

Round Tubing

- 1-1/4" Diameter
- Can be Ordered in 1"
- 16 Gauge
- Chrome

Order

3-2002-48
3-2002-60
3-2002-72
3-2002-96

Price

\$12.35
\$15.35
\$18.85
\$25.80

Size

48"L
60"L
72"L
96"L

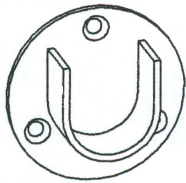

Open Flange With Countersunk Holes

- For 1-1/4" Tubing
- Chrome

Order

3-2004

Price

\$3.50

Size

1-1/4"

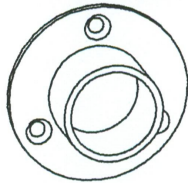

Closed Flange With Countersunk Holes

- For 1-1/4" Tubing
- Chrome

Order

3-2005

Price

\$3.50

Size

1-1/4"

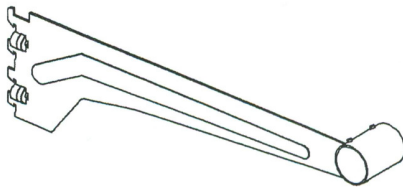

Hangrail Bracket

- For 1-1/4" Round Tubing
- Chrome
- 12"L, 1/2" Slot

Order

3-1610

Price

\$11.00

Size

12"L

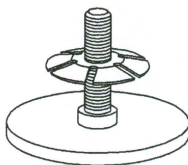

End Cap

- For Round Tubing
- 1" & 1-1/4" Dia.
- Chrome

Order

3-2009

Price

\$1.85

Size

1-1/4"

Kraemer Woodcraft Ltd.

11 Henry Street West, Box 510
St. Jacobs, ON N0B 2N0
Tel 519-664-2221 Fax 519-664-2105

info@kraemerwoodcraft.com
www.kraemerwoodcraft.com

